

LTS Series

Advanced Direct Laser
Diode CtS Imaging &
Exposure Systems

SAATI



Table of Contents

LTS Series Introduction	02
LTS Range	04
Specification Charts	06
LTS Series Features	08
Laser Characteristics	10
Workflow Capabilities	12
Software Capabilities	16
SAATI LTS 6080	20
SAATI LTS 6012	22
SAATI LTS 8012	24
SAATI LTS 1015	26
Registration Systems	28
Automation Systems	29
Index	30
Notes	31
Global Contact Information	BACK

Engage with SAATI



SAATI LTS Series

Introducing State-of-the-Art Laser Stencil Making by SAATI

SAATI has decades of experience in manufacturing and commercializing precision woven mesh, emulsion, stencil films and chemicals. Knowledge we have gained from our customers has been compiled, analyzed and applied to produce a full range of screen making equipment; the jewel of this collection is the LTS Series.

The SAATI LTS range takes into account the contemporary needs of stencil makers with an eye toward future challenges that will demand more efficient and precise results, delivered faster.

SAATI LTS machines are Direct Laser Diode CtS (LTS) Imaging & Exposure units. They surpass the versatility and printed results of other CtS systems, while simultaneously providing printers with savings to both the time and money spent producing stencils, as well as reducing ecological footprint.

After purchase, for both set up and in the event of technical issues, SAATI offers comprehensive support both in person and through collaborative remote viewing.

Scan or click the QR code to watch a video overview!



SAATI LTS Range

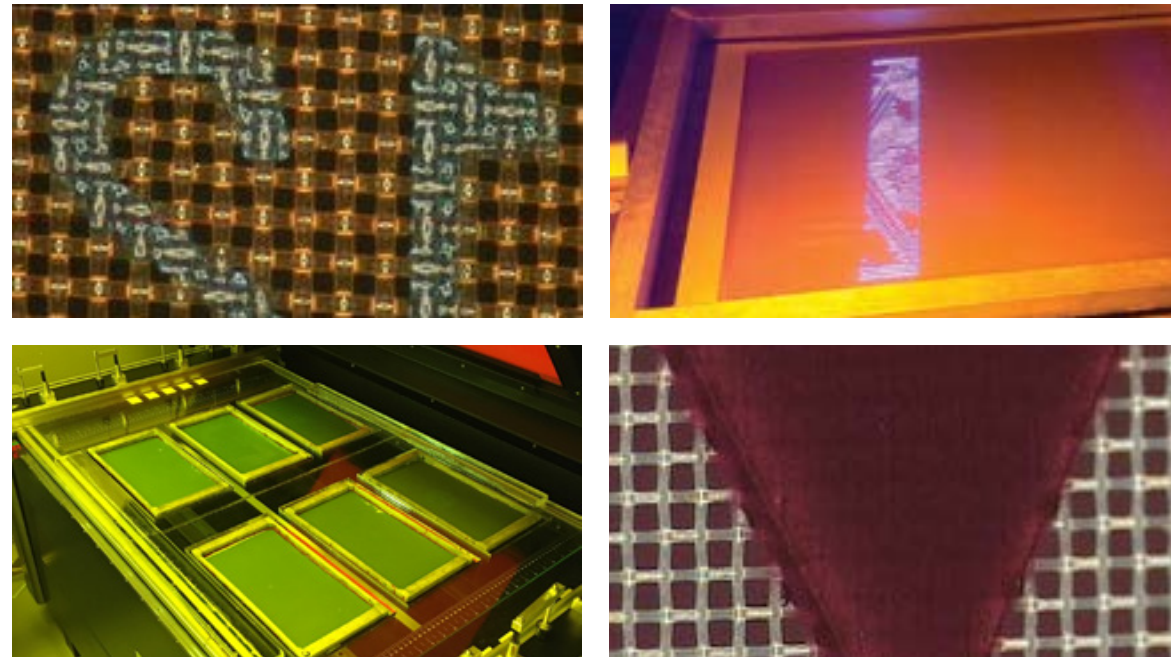

SAATI LTS machines use software-driven laser diodes to directly image artwork and expose the stencil material simultaneously.

The **405 nm laser array** is the correct wavelength for optimal through-cure so that stencils are processed rapidly, at high resolution (up to 2,540 dpi) and with no consumables like ink, wax or film, while drawing much less power than non-targeted wavelength light sources.

The included workflow software allows stencil makers to process art files in-house, and to place one or more images on one

or more stencils at the same time, further enhancing productivity and planning. In addition, remote viewing capabilities allow SAATI technicians to assist printers in calibrations without the need for face to face visits.

The affordable price point compared to other computer-to-screen technologies opens up higher resolution and more efficient computer-to-screen stencil making to a much broader group of screen printers, so the end result should be to enable access to higher quality and productivity, with a reduced carbon footprint.

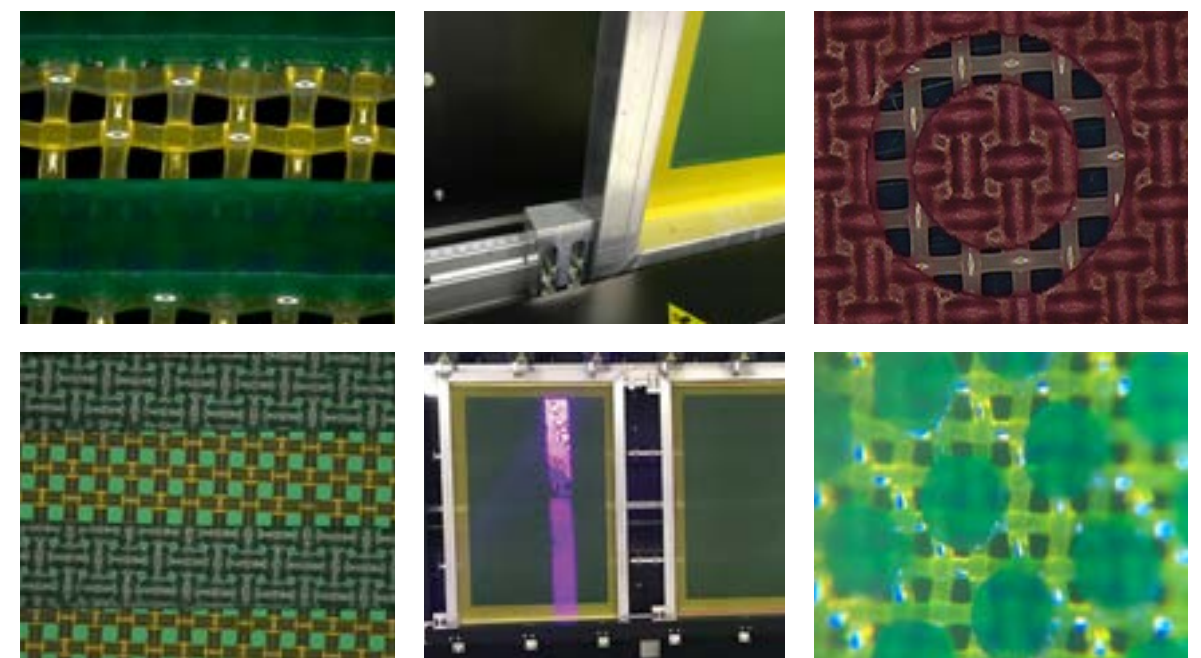
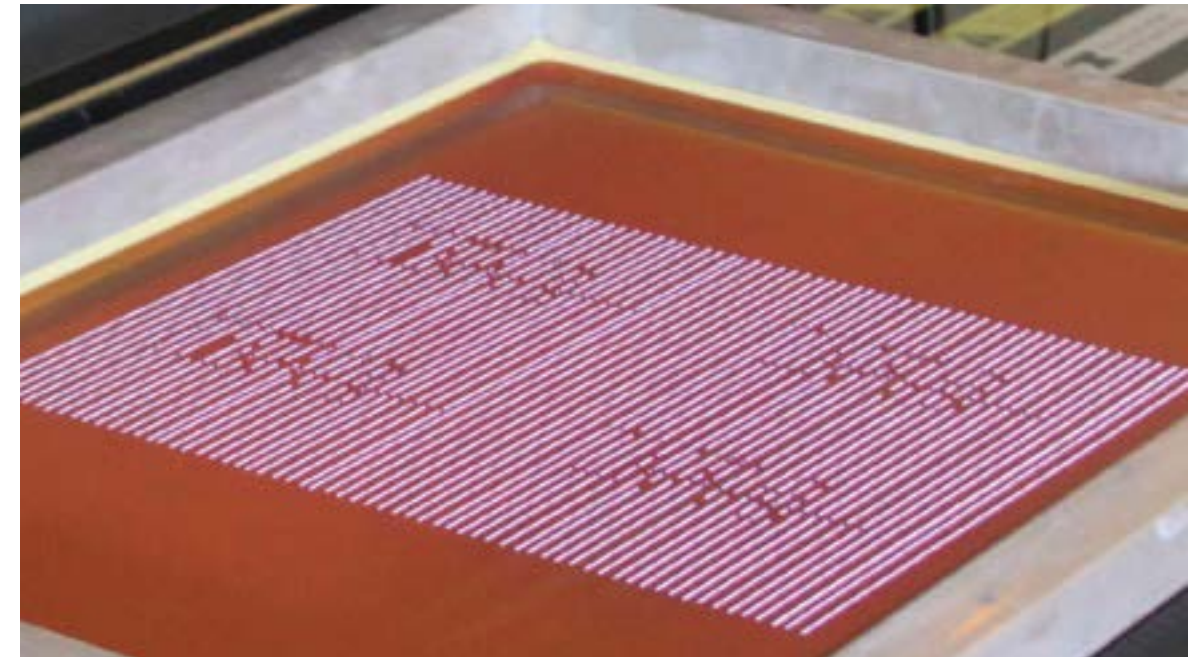

Specification Charts

SAATI LTS Series Individual Specifications

Machine	LTS 6080	LTS 6012	LTS 8012	LTS 1015
Lasers	96	96	128	160
Dimensions	167 x 82 x 93 cm 65.7 x 32.3 x 36.6"	220 x 58 x 163 cm 86.6 x 22.8 x 64"	220 x 58 x 163 cm 86.6 x 22.8 x 64"	260 x 68 x 200 cm 102.4 x 26.8 x 78.7"
Weight	597 kg / 1316 lbs	850 kg / 1874 lbs	925 kg / 2039 lbs	1200 kg / 2646 lbs
Max Exposure Area	60 x 80 cm 23.6 x 31.5"	60 x 120 cm 23.6 x 47.2"	80 x 120 cm 31.5 x 47.2"	100 x 150 cm 39.4 x 59.1"
Max Frame Size (x1)	85 x 110 cm 33.5 x 43.3"	105 x 160 cm 41.3 x 63"	105 x 160 cm 41.3 x 63"	150 x 190 cm 59.1 x 78.7"
Max Frame Sizes (x2)	holds more than two small frames	58 x 78 cm 23 x 31"	64 x 91 cm 25 x 36"	64 x 91 cm 25 x 36"
Power Consumption	350 W	800 W	800 W	1000 W

SAATI LTS Series Universal Specifications

Resolution	847 - 1016 - 1270 - 1693 - 2540
Wavelength	405 nm - the most effective at curing stencil material
Voltage	110 OR 240V
Interface	USB 2.0
Process Mode	Bi-Directional
Stencil Materials	Most kinds of emulsion & film
Max. Recom. Stencil Thickness	700 µm
Repeatability	Less than 0.1 mm
Sample Exposure Settings	Fabric Type SAATI Hi-R 120.34 (305.34) Color: Yellow Emulsion: SAATIgraf CTS7 EOM: 9 µm DPI: 1270 Power: 50 Speed: 300 SAATI 21-Step Exposure Level: Step 5 Time: Less than 3.5 Minutes

Maximum Frame Sizes and Example Configurations

for larger medium format screens 1 or 2 up vertical & glass free

for medium format screens 1 or 2 up vertical & glass free

for medium format screens 1 or 2 up vertical & glass free

small to medium format, horizontal glass down

Max Single Frame

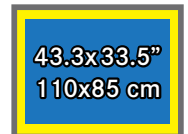
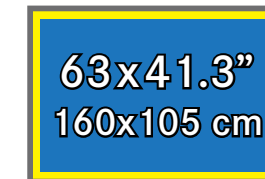
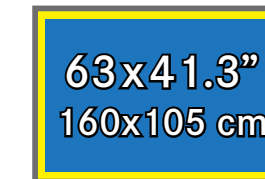
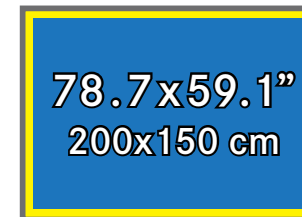

Example Frame Sizes

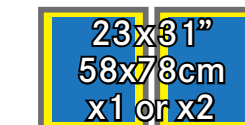
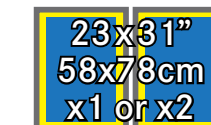
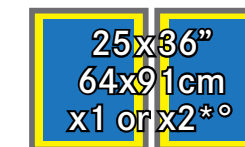
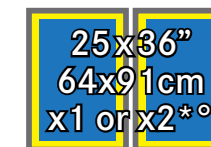

* For vertical format units 1015, 8012, 6080-VF: 2-up screen configurations must have identical dimensions
° For all units, all 2+ frame configurations must have identical frame profiles



LTS Series Features

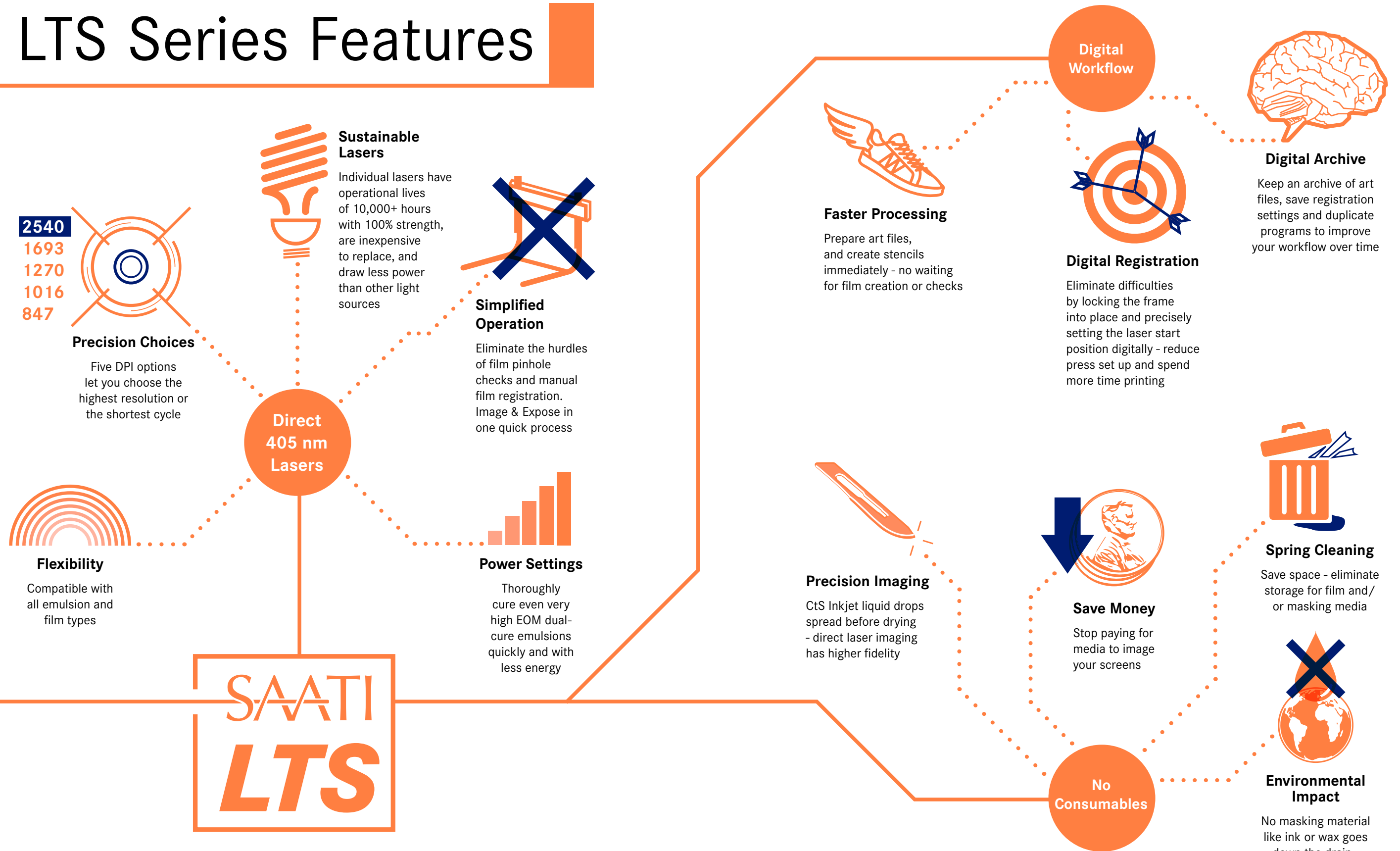

Laser Characteristics

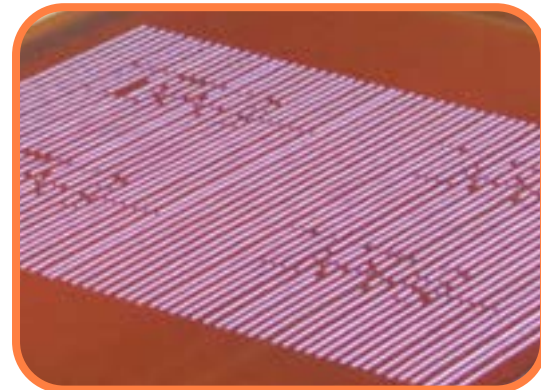
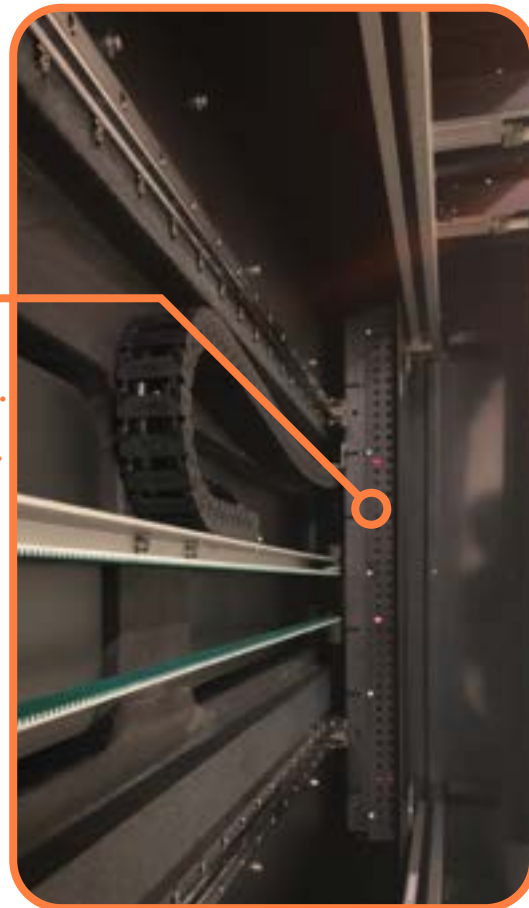
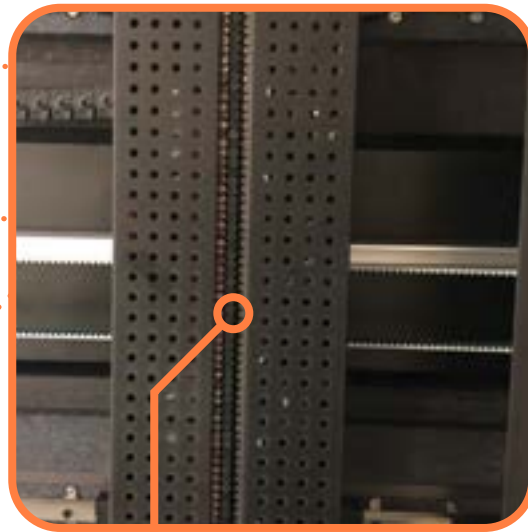

- Linear arrays of Blu-Ray Lasers on a belt-driven head, the system is durable and requires minimal maintenance
- The targeted light wavelength of the lasers maximizes curing speed and minimizes both power consumption and heat generation
- Individual Laser diodes last 10,000+ hours with 100% strength in optimal conditions, and are cost effective to replace



Once integrated into a production workflow, the SAATI LTS Series offers advantages over film, wax, and ink based output:

- Reduce art department supply costs while eliminating the issues associated with disposal of the processors chemistry, if a wet film system is being used to create final films
- True depiction of halftone dots when compared to inkjet style film processing
- No fading of films, no opacity issues to be concerned with
- No head purging, solvent cleaning, inkjet clogging, or head maintenance as there is no ink transferred
- Resolve more detailed halftones and details than lower resolution output devices using film or CTS
- Speed the production of screen making by delivering a press ready screen 50% faster than following the film-based model –no waiting for vacuum draw down time or waiting for good contact.
- Eliminate the film library and free up the space along with issues regarding lost or damaged film, and the time spent file searching, inspecting and repositioning to carrier sheets

Resolution & Workflow

Resolution Settings

The SAATI LTS has five resolution resolution settings, each tailored to a different types of image requirements

Low Setting

847

- Fastest processing times
- Superior to inkjet films

Middle Setting

1016

- Superior to inkjet/waxjet CtS resolution

1270

- Equivalent to many CtS systems

1693

- Superior to many CtS systems

High Setting

2540

- Image setter quality for the most demanding applications

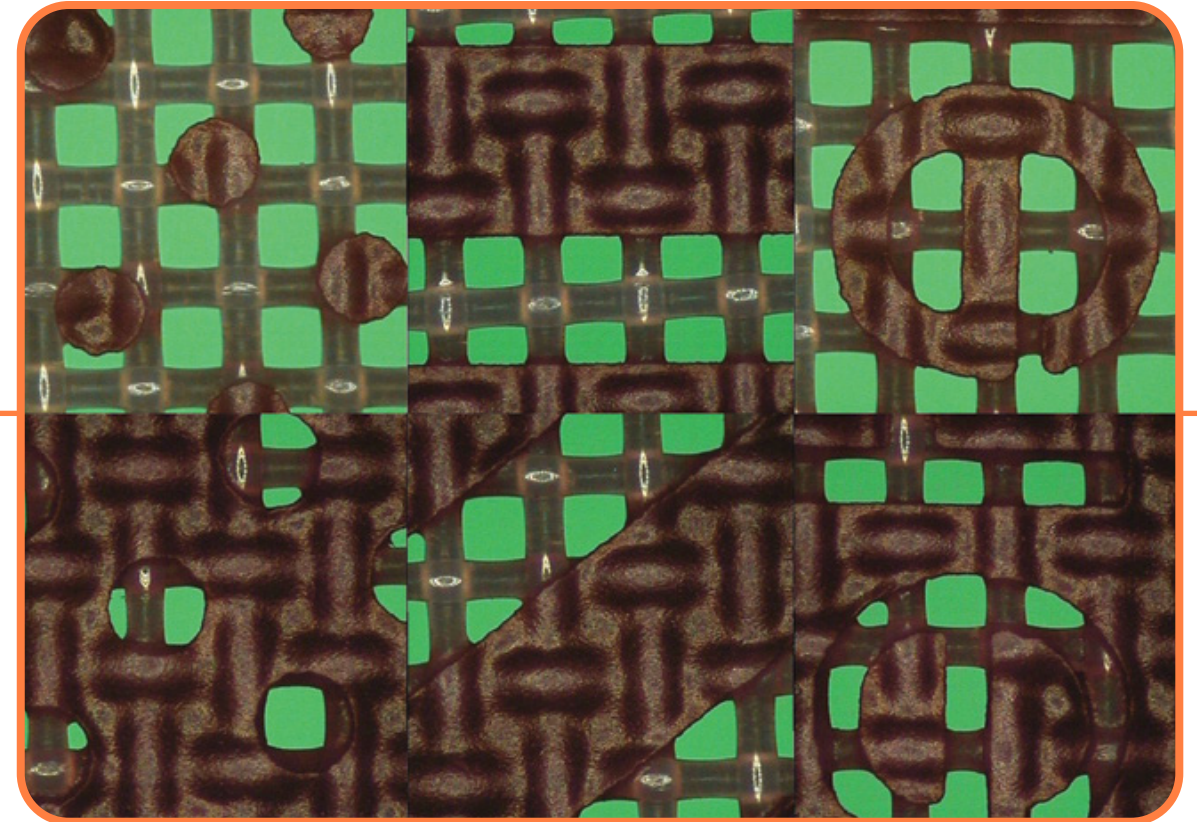

SAATI Mesh 43.80 (110/in) coated with Textil PHU - 2,540 DPI setting

Improvements to Workflow

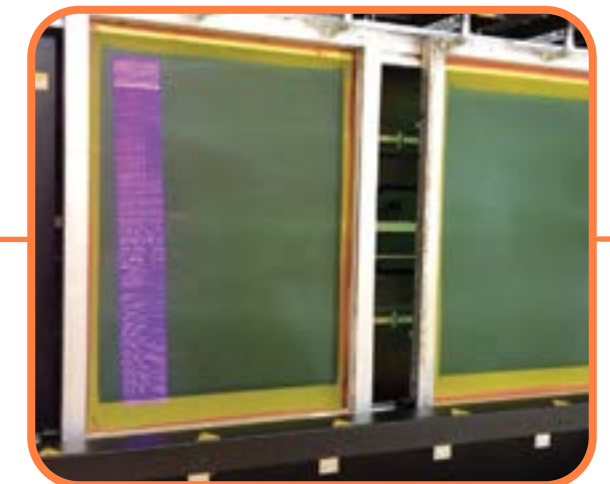
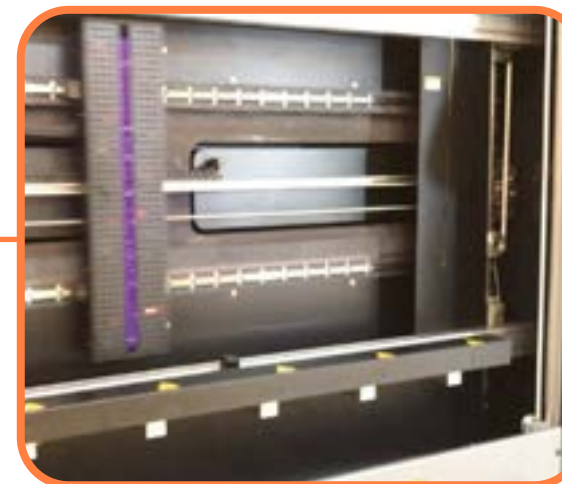
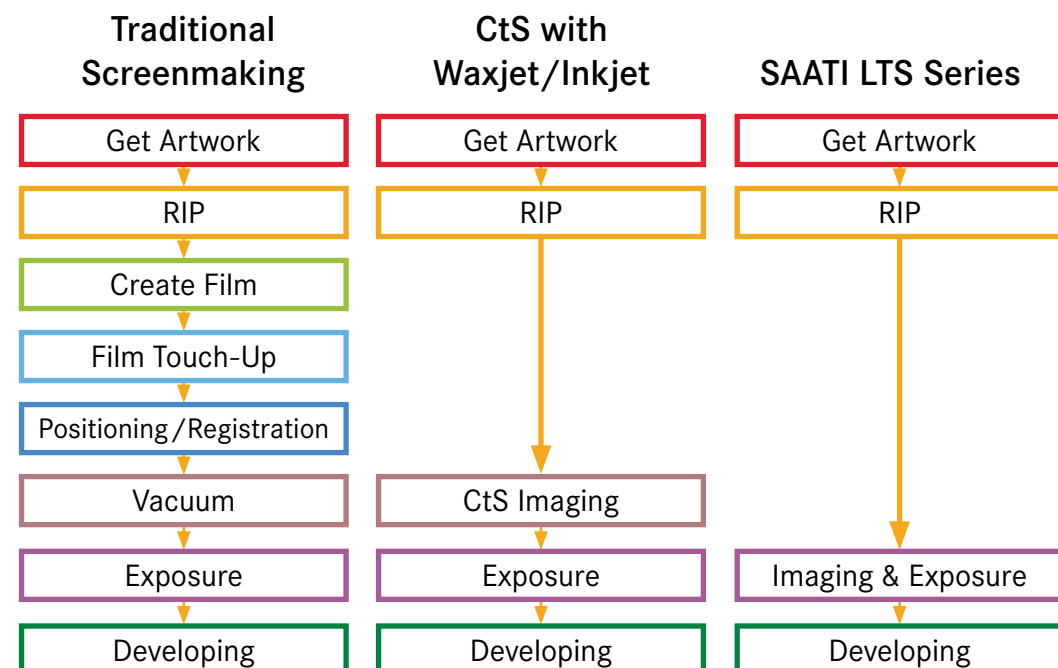

SAATI LTS Series

Workflow Capabilities

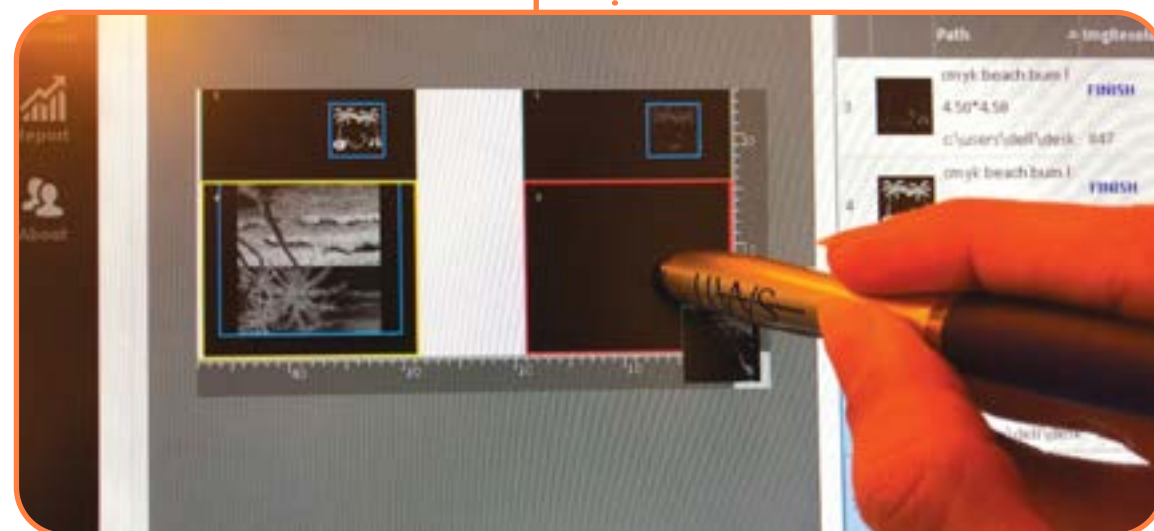
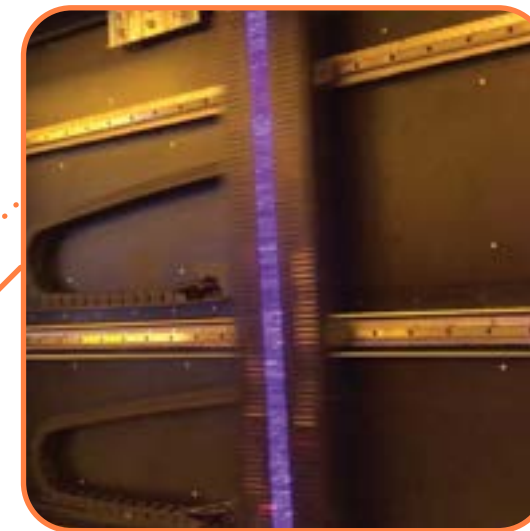

Drag & Drop multiple or single processed art files into automatic registration



85 LPI, SAATI Grafic Hu Red,
150.31 YE (380/in)

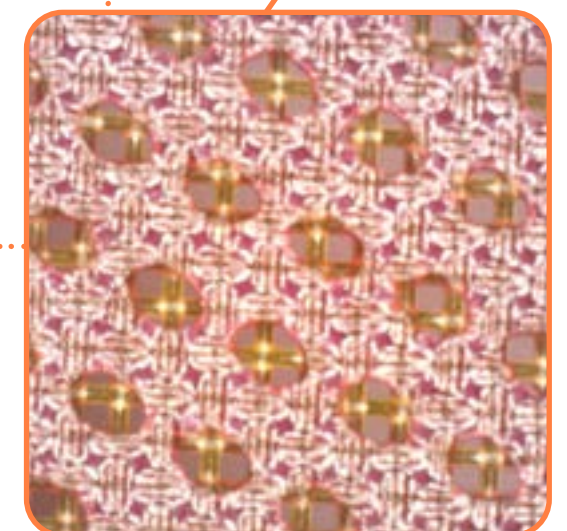

85 LPI SAATI Grafic HU Red
150.31 YE (380/in)

Software Capabilities



User Friendly Layout System

- Set size & location of image(s) and define exposure area
- Place multiple stencil images across 1 or more screens with touchscreen or mouse
- Finalized layouts go to queue for easy work management



Exposure Parameters

- Set the laser power and scan speed to effectively and thoroughly cure all emulsion and film types in under 3:00
- Customize settings and/or create standard templates for future use
- Proprietary file naming system automatically loads Netframe, Image Pattern & Exposure settings (not required)

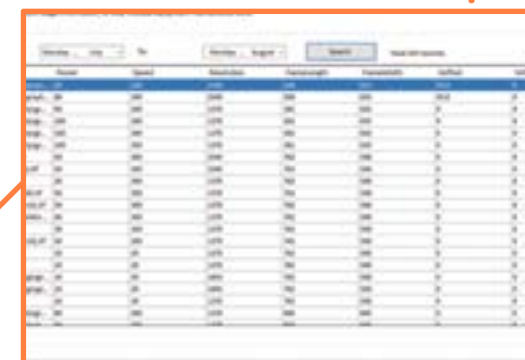

Create Your Own Digital Archive

- Processed files' settings are saved
- After screen imaging, layouts go to designated folder for archiving or deletion
- Create your own file archive for easy retrieval through the search function

DIGITAL WORKFLOW AND ARTWORK STORAGE

SAATI LTS Series

Software Capabilities



Get a Perfect Fit

- Alter the image size from within the software in X, Y or both directions
- Skew artwork to match infidelities seen in legacy inkjet stencils

ADVANCED ARTWORK EDITING TOOLS

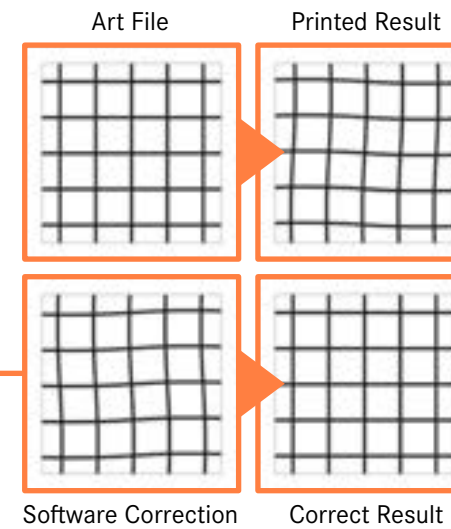

Image Adjustment

- LTS output files can be calibrated tile by tile in an X, Y grid
- Compensate for potential substrate distortion observed when combining processes other than screen printing
- Useful for hybrid transfers (match screen to digital), print finishing (printing UV highlights, adhesives for foils) for digital or offset prints, forming & die cutting



® - details cannot be printed cleanly



Line Refine

- Thicken or thin fine details in the art - down to 1 pixel
- Resolve otherwise too fine details without changing mesh and maintaining expected ink deposit
- Executed on the fly with files post-RIP - without the art department

Line Refine applied only to the ® will allow better flow of ink without affecting the rest of the art

SAATI LTS 6080

High Resolution Digital Direct Laser Image & Exposure Unit



Dimensions

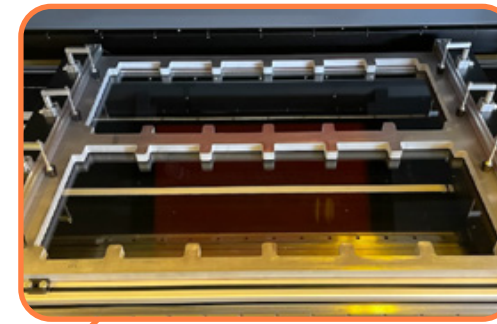
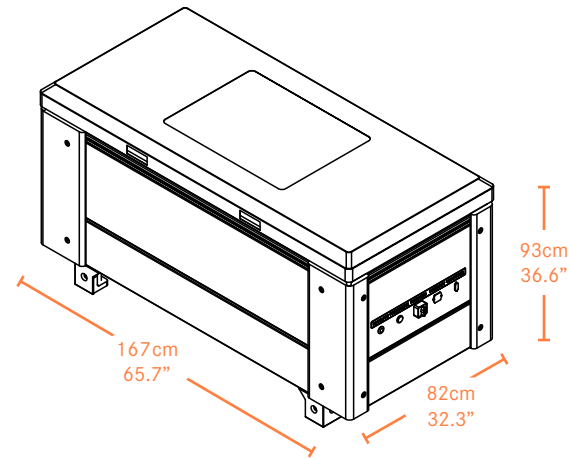

Adaptable to both leading registration systems & custom systems made to order for multi-screen programs

Lasers 96

Weight

597 kg
1316 lbs

Power



240V
global

110V
USA

350W
consumption

Characteristics

Facedown glass panel with enclosing lid

Adaptable to various types of screen registration systems

Safe Viewing Window for observing exposure program progress

Solid metal construction provides a vibration-free stencil making platform

Solid casters and slim build allow easy movement through standard doorways for unit placement

Maximum Exposure Area:
60 x 80 cm | 23.6 x 31.5"

Maximum Single Frame Size:
85 x 110 cm | 33.5 x 43.3"

SAATI LTS 6012

High Resolution Digital Direct Laser Image & Exposure Unit

Dimensions

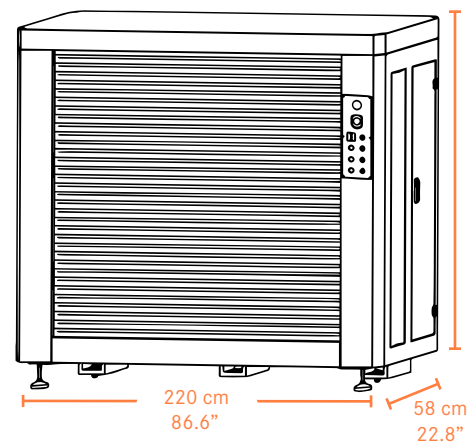

Characteristics

Glass-free vertical loading and frame lock system ensure accurate, easy screen placement and reduced pinholes

Solid metal construction provides a vibration free stencil making platform while maintaining a smaller footprint than other CtS machines

Large frame holding area enables simultaneous imaging & exposure of either large screens, or 1 or 2 standard size screens

Maximum Exposure Area:
60x120 cm | 23.6 x 47.2"



Lasers 96

Weight

850 kg
1,874 lbs

Power



240V
global

110V
USA

800W
consumption



Touch screen monitor with powerful workflow software

Easy to use control panel control carriages, shutter & emergency stop

Motorized safety shutter

Easy to use pedals engage and disengage the frame clamps

Max Frame Size: 1 screen up to 105 x 160 cm | 41.3 x 63"
or 2 Screens up to 58 x 78 cm | 23 x 31"

SAATI LTS 8012

High Resolution Digital Direct Laser Image & Exposure Unit



Dimensions

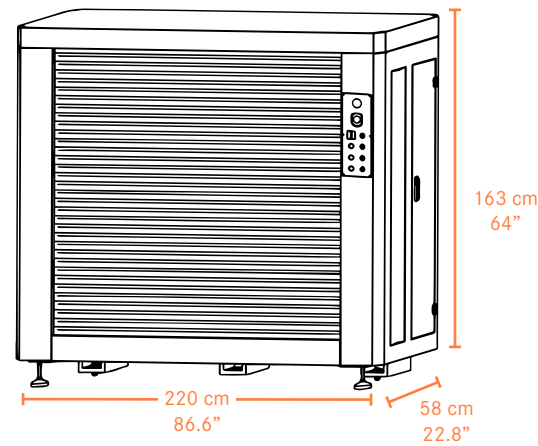

Lasers 128

Weight Power

925 kg
2,039 lbs



240V
global

110V
USA

800W
consumption

Characteristics

Glass-free vertical loading and frame lock system ensure accurate, easy screen placement and reduced pinholes

Solid metal construction provides a vibration free stencil making platform while maintaining a smaller footprint than other CtS machines

Large frame holding area enables processing larger single screens, or 1 or 2 standard textile screens

Maximum Exposure Area:
80 x 120 cm | 31.5 x 47.2"

Max Frame Size: 1 screen up to 105 x 160 cm | 41.3 x 63"
or 2 screens up to 64 x 91 cm | 25 x 36"



Touch screen monitor with powerful workflow software

Easy to use control panel control carriages, shutter & emergency stop

Motorized safety shutter

Easy to use pedals engage and disengage the frame clamps

SAATI LTS 1015

High Resolution Digital Direct Laser Image & Exposure Unit

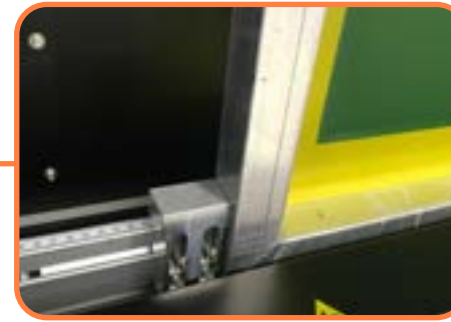

Lasers **160**

Dimensions

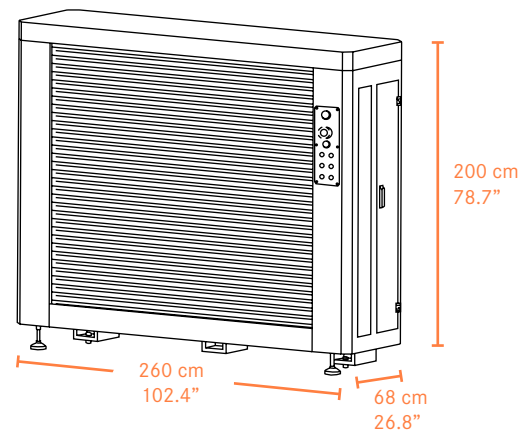

Weight

1,200 kg
2,646 lbs

Power



240V
global

110V
USA

1000W
consumption

Characteristics

Glass-free vertical loading and frame lock system ensure accurate, easy screen placement and reduced pinholes

Solid metal construction provides a vibration free stencil making platform while maintaining a smaller footprint than other CtS machines

Large frame holding area enables simultaneous imaging & exposure of either large screens, or 1 or more standard size screens

Touch screen monitor with powerful workflow software

Easy to use control panel control carriages, shutter & emergency stop

Motorized safety shutter

Easy to use pedals engage and disengage the frame clamps

Maximum Exposure Area:
100 x 150 cm - 39.4 x 59.1"

Max Frame Sizes: 1 screen up to 145 x 200 cm | 59.1 x 78.7"
or 2 two screens up to 63.5 x 91.5 cm | 25 x 36"

Registration Flexibility

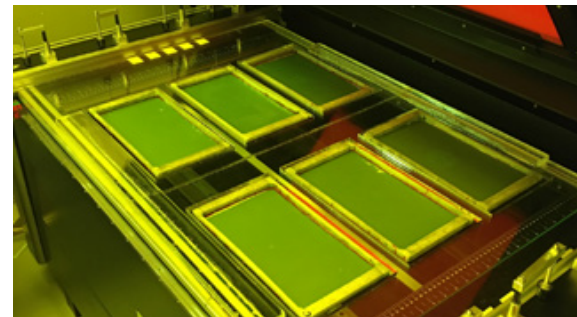
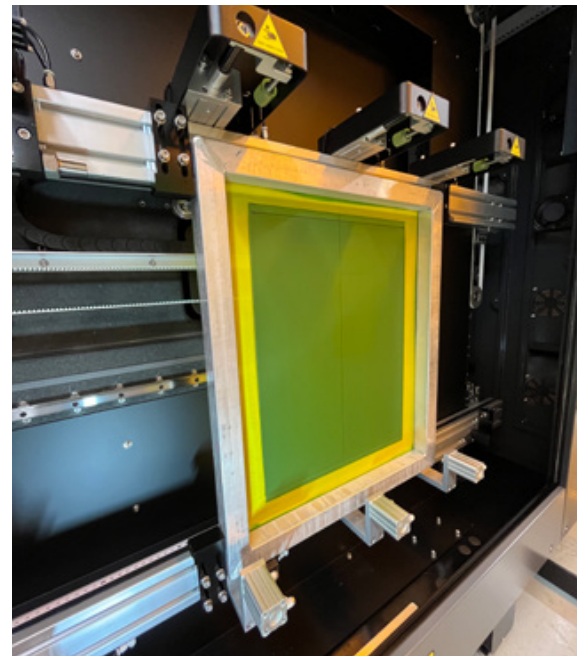
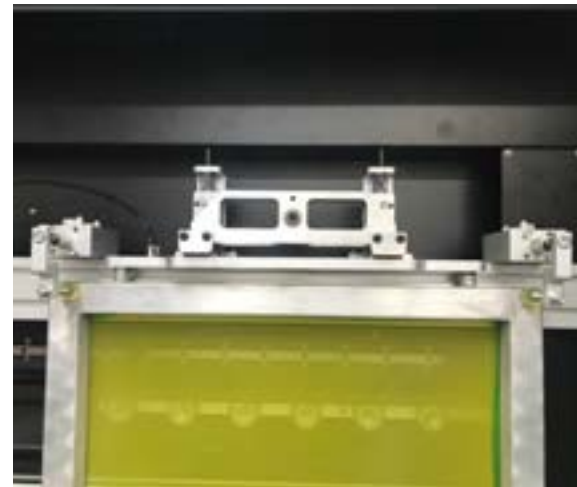
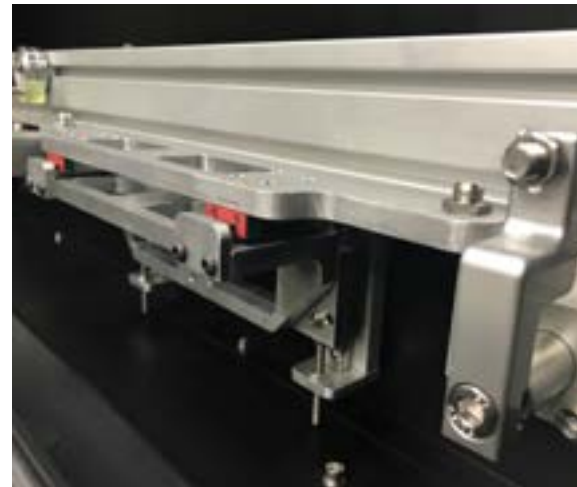

SAATI LTS units are fully compatible with all of the standard registration systems like M&R Tri-Lock, MHM and ROQ. They can be adapted to many custom systems as well.

You don't have to worry about compatibility with the systems you are already using, and with the versatile LTS software, placing art digitally on screens with registration systems affords you the ultimate simplicity and time savings benefits at press setup.

Automation Options



SAATI LTS vertical units can be customized at the manufacturing stage to connect a developing unit and feeder that takes your coated screens and gives you back a fully developed screens ready for drying.

Set a program and liberate yourself to complete other screen room tasks, and guarantee a uniform developing process that will further increase improvements to multi-color and halftone printing.

For those with space limitations, it is possible to incorporate a near-line system offered in conjunction with our partner Zentner, who combine modules for loading, washing, decoating, finishing and unloading according to your needs.

 **ZENTNER**



Interactive Product Index

Click a page number to view the product/topic

0-9

405 nm [04](#)

A

Archive [09, 17](#)

Automation [29](#)

C

Carbon Footprint [04](#)

Characteristics

LTS 1015 [26](#)

LTS 6080 [20](#)

LTS 6012 [22](#)

LTS 8012 [24](#)

Compatibility [08](#)

Consumption [06](#)

D

Dimensions [06](#)

Drag & Drop [14](#)

E

Exposure [17](#)

F

Features [08](#)

Frame Sizes [07](#)

I

Image Adjustment [18](#)

Image Distortion [19](#)

Imaging [12](#)

Imaging & Exposure [12](#)

Improvement [11, 12](#)

L

Laser Characteristics [10](#)

Laser Diode [02, 06, 08](#)

Laser Life [08, 10](#)

Layout [16](#)

Line Adjustments [19](#)

Line Refine [19](#)

LTS 1015 [06, 07, 26](#)

LTS 6080 [06, 07, 20](#)

LTS 6012 [06, 07, 22](#)

LTS 8012 [06, 07, 24](#)

M

Maintenance [11](#)

Maximum Frame Size
(single) [06, 07](#)

LTS 1015 [27](#)

LTS 6080 [20](#)

LTS 6012 [23](#)

LTS 8012 [25](#)

Maximum Frame
Size (x2) [06, 07](#)

Maximum Image Size [06](#)

Maximum Stencil
Thickness [06](#)

Models [06](#)

P

Power Consumption [06](#)

Power Settings [08](#)

R

Registration [09, 14, 28](#)

Remote Viewing [04](#)

Resolution [04, 06, 08, 12](#)

S

Software Capabilities [16, 18](#)

Stencil Examples [13](#)

Stencil Thickness [06](#)

Stencil Types [08](#)

Sustainability [09](#)

U

Universal Specifications [06](#)

V

Voltage [06](#)

W

Wavelength [04](#)

Weight [06](#)

Workflow Capabilities [12](#)

Notes

Take notes before you contact your [Local SAATI rep](#)

SAATI

SAATI S.p.a

Via Milano, 14
22070 Appiano Gentile (Co), Italy
Tel : +39 0319711
Fax: +39 031 933392
E-mail: info.it@saati.com

SAATI Americas Corp.

201 Fairview St. Extension
Fountain Inn, SC 29644
Toll-Free: +1 800 431 2200
Fax: +1 864 862 0089
E-mail: info.us@saati.com

SAATI Technical Fabrics (Tianjin) Co., Ltd.

Cross Of Saida 2nd Branch Road and Saida Century Avenue,
Xiqing Economic Development Area,
Tianjin, China 300385
Tel: +86 22 23960843
Fax: +86 22 23962116
E-mail: info.cn@saati.com

SAATI Korea Ltd.

22, Dangjeong-ro, Gunpo-si
Gyeonggi-do, 435-833, Korea
Phone: +82 31 429 9337
Fax: +82 31 429 9338

SAATI France

74 Route de Bapaume 80360 Sailly Saillisel, France
Phone: +33 3 22 85 77 00
Fax: +33 3 22 85 77 00
E-mail: info.fr@saati.com

SAATI Serigrafía Ibérica, S.a.

Pol. Ind. El Mijares, C/ Industria, nº 13 12550
Almazora, Castellón, Spain
Phone: +34 964550688
Fax: +34 964551049
E-mail: info.es@saati.com

SPT Sales & Marketing GmbH

Kurpfalzring 100A, 69123 Heidelberg, Germany
Phone: +49 62217485 27
Fax: +49 62217485 25
E-mail: spt@spt-gmbh.com

CST GmbH

Königsberger Str. 117, 47809 Krefeld, Germany
Phone: +49 2151 1592260
Fax: +49 2151 520329
E-mail: office@c-s-t.de

SAATI is Social

Contact SAATI